

OKIDATA[®]

OKIPAGE[™]6e

User's Guide



Every effort has been made to ensure that the information in this document is complete, accurate, and up-to-date. OKIDATA assumes no responsibility for the results of errors beyond its control. OKIDATA also cannot guarantee that changes in software and equipment made by other manufacturers and referred to in this guide will not affect the applicability of the information in it. Mention of software products manufactured by other companies does not necessarily constitute endorsement by OKIDATA.

Copyright 1997 by OKIDATA. All rights reserved.

First edition July, 1997.

Written and produced by the OKIDATA Publications Services Dept.

Please address any comments to:

Publications Services Department
OKIDATA
532 Fellowship Road
Mount Laurel, New Jersey 08054

<http://www.okidata.com>

OKIDATA is a registered trademark of Oki Electric Industry Company, Ltd.; Marque déposée de Oki Electric Industry Company, Ltd.; Marca Registrada, Oki Electric Industry Company, Ltd. OKIPAGE is a trademark of OKI America, Inc.

Energy Star is a trademark of the United States Environmental Protection Agency.

TrueType is a registered trademark of Apple Computer Company.

Hewlett-Packard, HP, and LaserJet are registered trademarks of Hewlett-Packard Company.

IBM is a registered trademark of International Business Machines Corp.

Microsoft and MS-DOS are registered trademarks and Windows is a registered trademark of Microsoft Corporation in the U. S. and other countries.

Intellifont is a registered trademark of Compugraphic Corporation.

Adobe, PostScript are trademarks of Adobe Systems Inc. which may be registered in certain jurisdictions.

Safety Instructions

Your OKIDATA printer has been carefully designed to give you years of safe, reliable performance. As with all electrical equipment, however, there are a few basic precautions you should take to avoid hurting yourself or damaging the printer:

- Read the setup instructions in this handbook carefully. Be sure to save it for future reference.
- Read and follow all warning and instruction labels on the printer itself.
- Unplug the printer before you clean it. Use only a damp cloth; do not use liquid or aerosol cleaners.
- Place your printer on a firm, solid surface. If you put it on something unsteady, it may fall and be damaged; if you place it on a soft surface, such as a rug, sofa, or bed, the vents may be blocked, causing the printer to overheat.
- To protect your printer from overheating, make sure all openings on the printer are not blocked. Don't put the printer on or near a heat source, such as a radiator or heat register. Keep it out of direct sunlight. Allow enough room around the printer for adequate ventilation and easy access to the paper trays.
- Do not use your printer near water, or spill liquid of any kind into it.
- Be certain that your power source matches the rating listed on the back of the printer. If you're not sure, check with your dealer or with your local power company.
- Your printer has a grounded, 3-prong plug as a safety feature, and it will only fit into a grounded outlet. If you can't plug it in, chances are you have an older, non-grounded outlet; contact an electrician to have the outlet replaced. Do not use an adapter to defeat the grounding.
- The printer must be installed near a power outlet which remains easily accessible.
- To avoid damaging the power cord, don't put anything on it or place it where it will be walked on. If the cord becomes damaged or frayed, replace it immediately.
- If you are using an extension cord or power strip with the printer, make sure that the total of the amperes required by all the equipment on the extension is less than the extension's rating. The total ratings of all equipment plugged into the outlet should not exceed 15 amperes.

- Do not poke anything into the ventilation slots on the printer; you could get a shock or cause a fire.
- Aside from the routine maintenance described in this handbook, don't try to service the printer yourself; opening the cover may expose you to shocks or other hazards.
- Do not make any adjustments other than those outlined in the handbook: you may cause damage requiring extensive repair work. See Section 5 for information on how to get your printer serviced by qualified OKIDATA technicians.

If anything happens that indicates that your printer is not working properly or has been damaged, unplug it immediately and follow the procedures in Section 5 for having your printer serviced.

These are some of the things to look for:

- The power cord or plug is frayed or damaged.
- Liquid has been spilled into the printer, or it has been exposed to water.
- The printer has been dropped, or the cabinet is damaged.
- The printer doesn't function normally when you're following the operating instructions.

Federal Communications Commission Radio Frequency Interference Statement for 120-Volt Models

WARNING: This equipment has been tested and found to comply with the limits for a Class B digital device, pursuant to Part 15 of the FCC Rules. These limits are designed to provide reasonable protection against harmful interference in a residential installation. This equipment generates, uses and can radiate radio frequency energy and, if not installed and used in accordance with the instructions, may cause harmful interference to radio communications. However, there is no guarantee that interference will not occur in a particular installation. If this equipment does cause harmful interference to radio or television reception, which can be determined by turning the equipment off and on, the user is encouraged to try to correct the interference by one or more of the following measures:

- Reorient or relocate the receiving antenna.
- Increase the separation between the equipment and receiver.
- Connect the equipment into an outlet on a circuit different from that to which the receiver is connected.

- Consult the dealer or an experienced radio/TV technician for help.

It is the responsibility of the user to obtain the required shielded cable in order to ensure compliance of this equipment with FCC regulations.

Changes or modifications not expressly approved by Okidata may void your authority to operate this device.

Industry Canada Radio Interference Statement for 120-Volt Models

This apparatus complies with the Class “B” limits for radio interference as specified in the Industry Canada Radio Interference Regulations.

Cet appareil est conforme aux critères établis pour la Classe “B” en ce qui concerne les interférences radio, tel que spécifié par Industry Canada dans les Règlements relatifs aux Interférences Radio.

Federal Communications Commission Radio Frequency Interference Statement for 230/240-Volt Models

WARNING: This equipment has been tested and found to comply with the limits for a Class A digital device, pursuant to Part 15 of the FCC Rules. These limits are designed to

provide reasonable protection against harmful interference when the equipment is operated in a commercial environment. This equipment generates, uses and can radiate radio frequency energy and, if not installed and used in accordance with the instructions, may cause harmful interference to radio communications. Operation of this equipment in a residential area is likely to cause harmful interference in which case the user will be required to correct the interference at his own expense.

It is the responsibility of the user to obtain the required shielded cable in order to ensure compliance of this equipment with FCC regulations.

Changes or modifications not expressly approved by Okidata may void your authority to operate this device.

**Industry Canada
Radio Interference Statement for
230/240-Volt Models**

This apparatus complies with the Class “A” limits for radio interference as specified in the Industry Canada Radio Interference Regulations.

Cet appareil est conforme aux critères établis pour la Classe “A” en ce qui concerne les interférences radio, tel

que spécifié par Industry Canada dans les Règlements relatifs aux Interférences Radio.

**European Union Council of the European
Communities
Statement of Electromagnetic Conformance for
230/240-Volt Models**

This product complies with the requirements of the Council Directive 89/336/EEC on the approximation of the laws of the member states relating to electromagnetic compatibility.

Ce matériel est conforme aux dispositions de la Directive du Conseil 89/336/CEE applicables à l’approximation de la législation des Etats membres en ce qui concerne la compatibilité des équipements électromagnétiques.

Este producto cumple con los requisitos de la Directiva del Consejo 89/336/CEE sobre la aproximación de la legislación de los Estados Miembros por cuanto respecta a la compatibilidad electromagnética.

Este produto obedece aos requisitos da Directiva do Conselho 89/336/CEE sobre a aproximação das leis dos estados membros relativamente à compatibilidade electromagnética.

Table of Contents

Printer Features	1
Optional Accessories	1
Consumables	1
Okidata Online	2
Check the Contents	2
No CD-ROM Drive?	2
Printer Components	3
Section 1: Setting Up Your Printer	4
Remove the Protective Sheet	4
Installing Toner	5
Choosing Paper	7
Paper Sizes	7
Paper Weight	7
Installing Paper	8
Paper Exit Paths	9
Top Paper Exit	9
Rear Paper Exit	9
Manual Feed	10
Transparencies/Adhesive Labels	10
Printing Envelopes	11
Choosing Envelopes	11
Connecting Your Printer	12

Section 2: Installing Printer Software	13
Windows 95	13
Windows 3.1	14
Windows NT 3.51	15
Windows NT 4.0.....	16
DOS Operator Panel	16
Using the Online Status Monitor	17
Setting Features in the Online Operator Panel	18
Section 3: Printer Maintenance	19
Replacing the Toner Cartridge	19
Toner Cartridge Life	21
When to Replace the Toner Cartridge	21
Replacing the Image Drum Cartridge	22
Resetting the Image Drum Counter	23
Image Drum Cartridge Life	23
When to Replace	23
Running a Cleaning Page	24
Cleaning the LED Array	25
Expanding Memory	26

Section 4: Problem Solving	27
Clearing Paper Jams	27
Paper Input Jam	27
Paper Feed Jam	27
Paper Exit Jam (top)	28
Paper Exit Jam (rear)	28
Print Quality Problems	29
Software Problems	31
Hardware Problems	32
Section 5: Service and Support	33
Your Dealer	33
Okidata Customer Information Center	33
Customer Service Representatives	33
Faxable Facts	34
Okidata Regional Service Depot	34
Purchasing Supplies	35
Warranty	36
Overnight Exchange	37
Service Centers	38
Index	39
Material Safety Data Sheet	42

Congratulations! You have selected a printer with fast output, excellent print quality, and easy operation.

Your printer's features include:

- 6 PPM output
- Sharp 600 dpi class print quality with OKI Smoothing Technology
- Oki Hiper-W Emulation (PJL), a high-performance Windows print driver
- HP®PCL® 5e Emulation
- IBM® Proprinter/Epson FX Emulations
- 45 resident scaleable fonts, plus 4 bitmap fonts
- 1 MB RAM with Enhanced Memory Management
- 100 sheet universal letter size paper tray
- Manual feed for envelopes and special documents
- On-screen Status Monitor for real-time printer status, and soft operator panel for printer setup and control from your computer
- Compatible with Window® 3.11, Windows 95 and Windows NT 4.0 and 3.51
- Bi-directional IEEE 1284 parallel interface

Optional Accessories

- 250 sheet universal Second Paper Tray Mechanism (Part 70024501)
- Letter/Legal Universal Paper Tray (Part 70025201)
- 100 sheet/50 envelope Multi-Purpose Feeder (Part 70025101)
- 1 MB Memory Expansion Board with a SIMM socket for additional expansion to 17 MB (Part 70029701)
- SIMM modules for expanding memory (See page 26)

Consumables

- Toner "e" Series (Part 52107201)
- Image Drum "e" Series (Part 56116801)

As an Energy Star Partner, Okidata has determined that this product meets the Energy Star guidelines for energy efficiency.

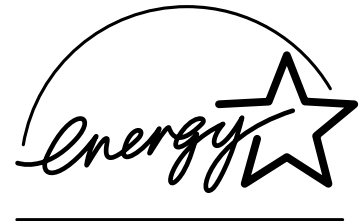

OKIDATA Online

For more information about your printer:

- ✓ See the Online Manual installed with the printer software.
- ✓ Visit the OKIDATA Web Site at

<http://www.okidata.com>

for the latest information on:

- Product Guides
- Customer Support
- Software Drivers
- Corporate Information
- Online Dealers
- Documentation

Check Contents

Unpack your printer. You should have:

1. OKIPAGE 6e Printer (with Image Drum installed)
2. CD-ROM
3. 3.5" Driver Disk
4. User's Manual
5. Toner Cartridge
6. Power Cord
7. Lightproof plastic bag (for storing image drum if printer must be shipped)

If anything is missing, contact your dealer.

No CD ROM Drive?

- Visit the Okidata web site at <http://www.okidata.com> and download the printer drivers.
- The enclosed 3.5" diskette contains a Windows driver that will allow you to use your printer right away. Follow the instructions in the readme file on the diskette to install it. To obtain a complete set of diskettes, including the Status Monitor, call 1-888-232-8530 and request the appropriate kit number.

Windows 95 #MS9629

Windows 3.x #MS9632

DOS Operator Panel #MS9633

Windows NT 3.51 #MS9630

Windows NT 4.0 #MS9631

Printer Components

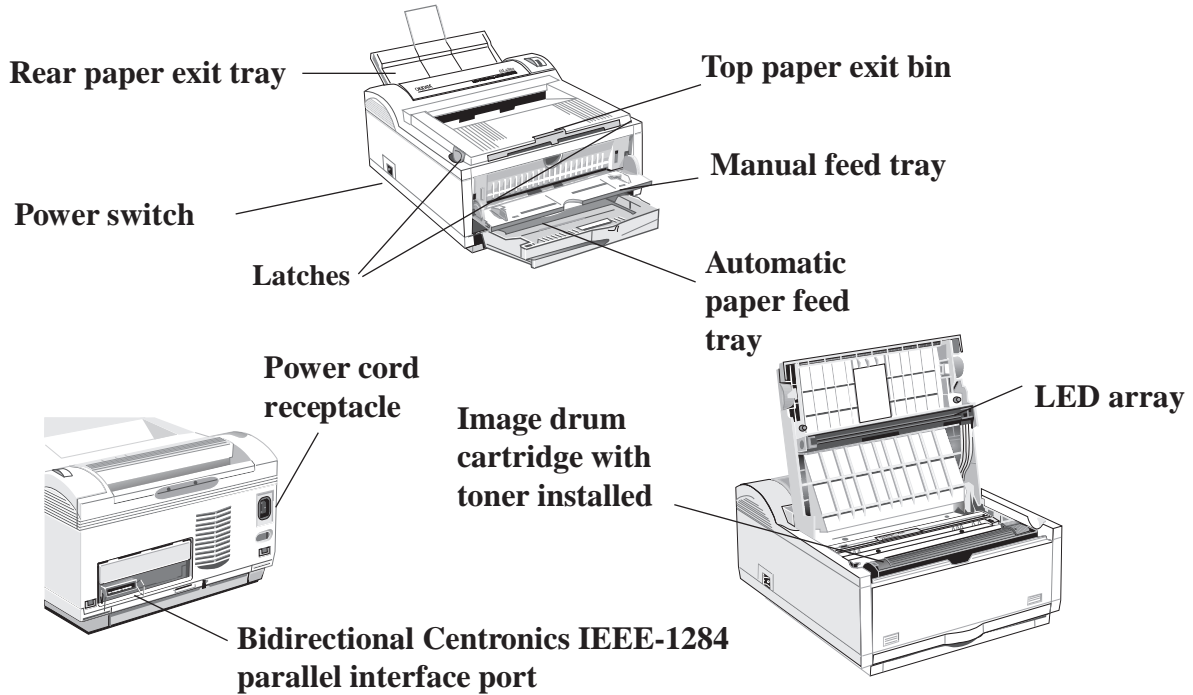

Section 1: Setting Up Your Printer

Remove the protective sheet

1. Press latches and open the cover.

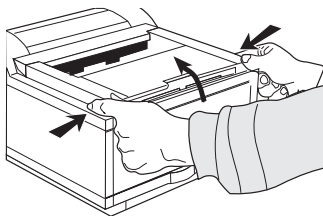

2. Remove the image drum.

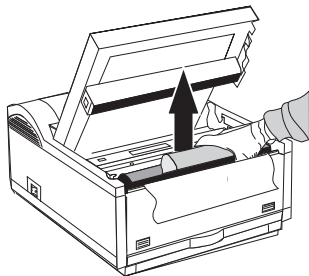

3. Remove the protective sheet.

✓ *Be Careful: do not touch the Image Drum's green surface.*

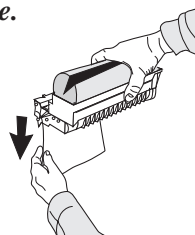

4. Replace the image drum.

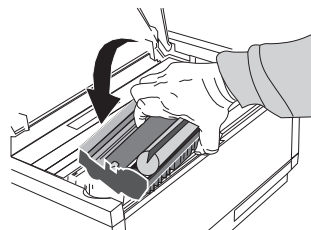

Installing Toner

1. Remove the sponge and discard.

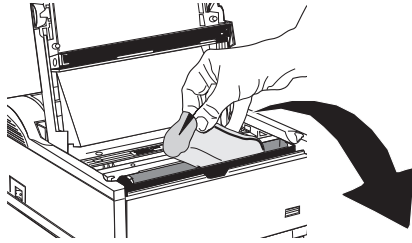

2. Unwrap the toner cartridge.

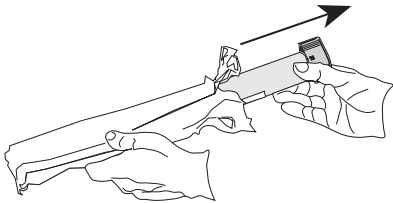

3. Shake the toner cartridge to evenly distribute toner.

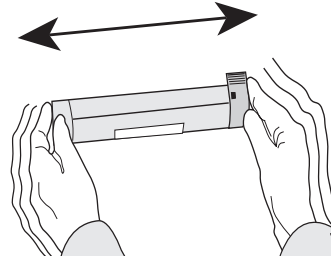

4. Remove the tape.

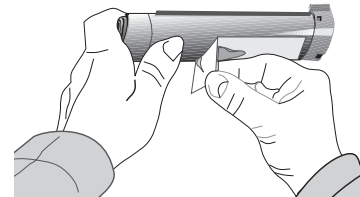

5. Place left side of toner cartridge under the tab, then lower cartridge into well matching groove and slot.

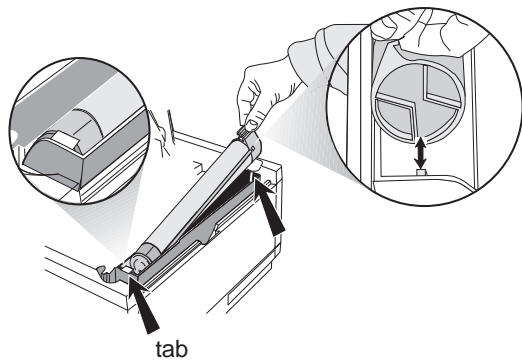

6. Push the blue lever forward.

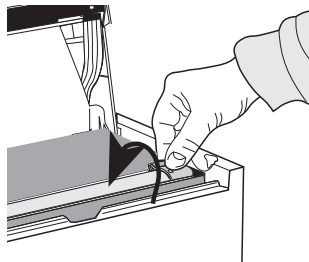

7. Close the printer cover firmly.

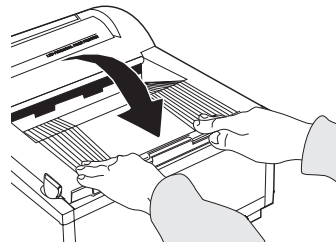

✓ *If you get toner on your clothing, brush it off with a dry cloth. Wash clothing in cold water; hot water sets toner.*

Choosing Paper

- Use a paper weight of 16 to 24 lb. in the Paper Tray and 16 to 32 lb. for manual feed.
- For best results, use paper that is smooth and of high quality, such as copier paper or paper with a Sheffield rating of 250 or less.
- Store paper in its ream wrapper until you are ready to use it. Keep it away from moisture or other conditions that can cause it to wrinkle or curl.
- Preprinted forms must not scorch, melt, offset, or release hazardous emissions when heated to 392°F (200° C) for 0.1 second.
- Avoid printing on both sides of the paper for more than a few pages, or on preprinted documents that have been in a photocopier.
- Try paper before you buy it in quantity.

Using Recycled Print Media

Recycled paper should be restricted to 20% to 35% Post Consumer Content and not exceed 50%. Paper must be relatively stiff and have minimum edge curl. Paper should be white and bright for maximum

contrast. The surface should be smooth, clean, and stable electrically and dimensionally.

*Recycled paper used by OKIDATA printers must be specifically denoted by the paper manufacturer to be for laser printers, or laser guaranteed or compatible. **Using media outside these specifications may cause problems requiring service that will not be covered by OKIDATA warranty or service agreements.***

The following recycled paper has been tested and approved for use in OKIDATA printers.

- Weyerhaeuser, Lynx Opaque, 20% PCW, 20lb., 28 lb. and Laser Copy, 20 lb.
- Union Camp Great White (Laser), 25% PCW, 20lb., 24lb.
- International Paper, Beckett Division, Enhanced Marble, 50% Recycled, 20% PCW, 24lb.
- International Paper, Hammermill Division, Savings DP, 20% PCW, 20 lb.
- Georgia Pacific, GeoCycle, 20% PCW, 20lb.
- James River, WordPro Laser, 20% PCW, 20lb., 24lb.
- Warren, SpectraTech, Gloss and Matte, 10% PCW, 28lb., 32lb.
- Cross Pointe, Worx, 50% Recycled, 20% PCW
- Strathmore, Script Bright White Wove, 50% Recycled

Installing Paper

1. Push the paper tray handle to release the tray.

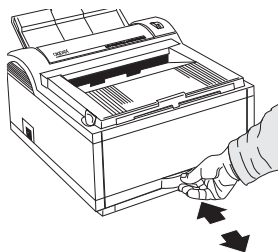

2. Remove the paper tray.

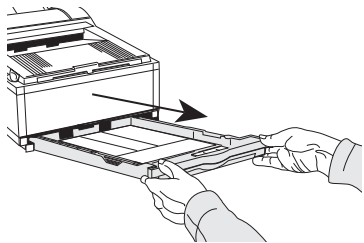

3. Adjust the paper guides.

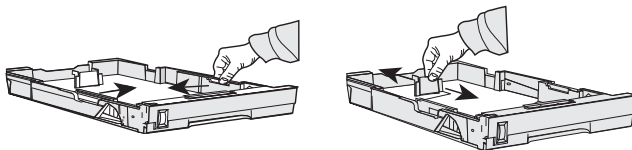

4. Insert up to 100 sheets of 20 lb. paper.
✓ *Do not fill above PAPER FULL mark.*

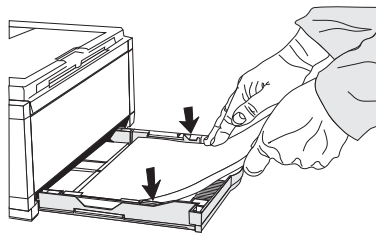

5. Re-insert the paper tray.

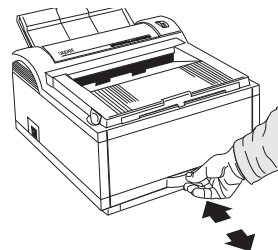

Paper Exit Paths

Top Paper Exit

- Printed pages exit face down.
- Pages are stacked in the order printed.
- Exit bin holds 100 sheets (20 lb. paper)

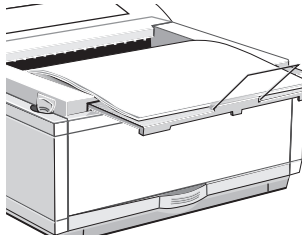

Pull the front exit extender forward. Lift out the metal support bar.

✓ *Do not change the paper exit path during printing—a paper jam may occur.*

Rear Paper Exit

- Always use rear exit for printing on heavy paper, envelopes, labels and transparencies.
- Printed pages exit face up in reverse order.
- Exit tray's maximum capacity is 50 sheets (20 lb. paper).

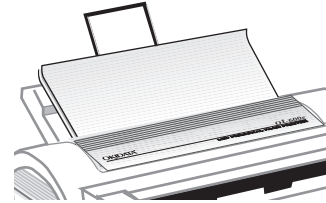

Pull out the rear exit extender until it locks into place. Lift out the metal support bar.

To return to top exit, fold in the metal support bar and push the rear exit extender in until it clicks into place.

Manual Feed

Use manual feed for printing envelopes, transparencies, legal and odd size paper.

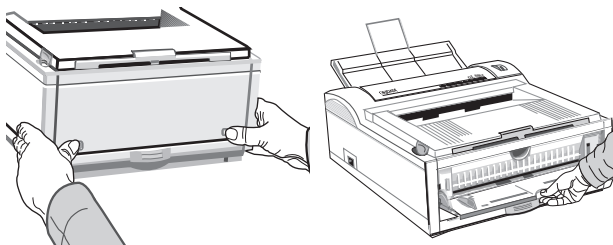

1. Press the push points on the front panel to release the manual feed tray. Pull the tray down.

2. Adjust the tray guides. Insert a sheet of paper until the printer grips it. When using letterhead paper, insert letterhead edge in first, face up.
3. Set your software application for manual feed and paper size, then issue a print command.

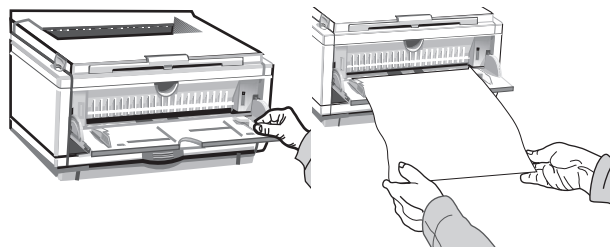

Transparencies/Adhesive Labels

- Use Manual Feed.
- Use rear output.
- Should be specifically made for laser printers or photocopiers.
- Must be able to withstand 200°C for 0.1 sec.
- Labels should cover entire carrier sheet.
- sheet or adhesive **must not** be exposed to any part of the printer.

Printing Envelopes

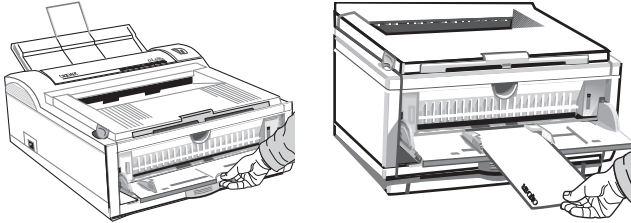

1. Pull out the rear exit extender until it locks and lift out the support bar. Pull down the manual feed tray and adjust the paper guides.
2. Insert the envelope—flap down and on the left—until the printer grips it.
3. Set envelope size and landscape orientation in your software, then issue the print command.

Choosing Envelopes

- Always use rear output.
- No windows or metal clasps.
- Paper no heavier than 28 lbs.
- Smooth even surface.
- No self-sealing flaps.
- Seams down the sides, not across the middle.
- Squared-off flaps that do not cover the print area.

Connecting Your Printer

Make sure your printer is not plugged in and your computer is turned off.

The interface cable must be an IEEE 1284 compliant bidirectional parallel cable, and must be shielded and UL and CSA approved.

1. Plug the interface cable into the parallel socket in the printer. Plug the other end into your computer.

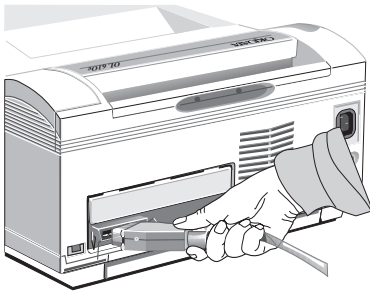

2. Plug the power cord into the printer, then into a grounded outlet.

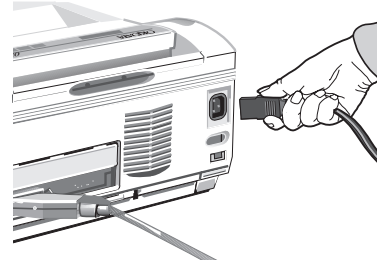

3. Switch the printer on. The Ready light comes on.



Section 2: Installing Printer Software

Installing the OKIPAGE 6e Software for Windows 95

1. Turn on your computer to start Windows.
✓ *If “New Hardware Found” prompt appears, click “Driver from disk provided by hardware manufacturer,” then click OK. Insert the OKIPAGE 6e CD into your CD-ROM drive and go to step 9, then follow the instructions on your screen.*
2. Close any open applications.
3. Insert the OKIPAGE 6e CD into your CD-ROM drive.
4. Click the **Start** button on the Windows taskbar, then choose **Settings**→**Printers**.
5. Double-click the **Add Printer** icon.
6. The Add Printer Wizard screen appears; click **Next** to begin the installation.
7. Select Local or Network printer, (depending on your configuration), then click **Next**.

8. Click **Have Disk**.

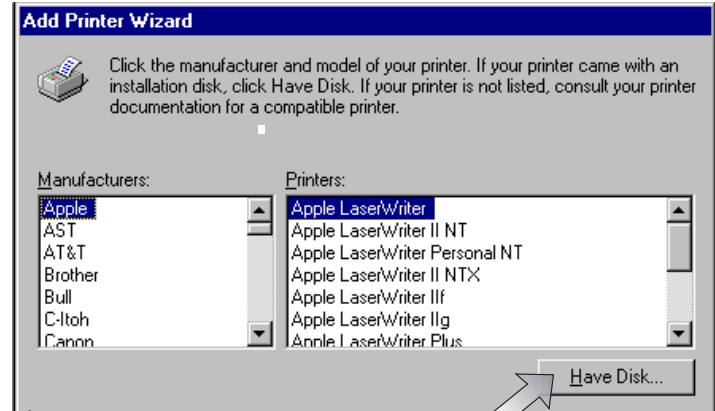

9. Enter d:\ (or the location of your CD-ROM drive), then click **OK**.
10. **OKIDATA Okipage 6e Hi-Per W** appears; click **Next**.
11. Click **LPT1 Printer Port**, then click **Next**.
12. Continue with the installation following the instructions on your screen.

Installing the OKIPAGE 6e Software for Windows 3.1

1. Insert disc into the CD-ROM drive.
2. Click **File**.



3. Click **Run...**

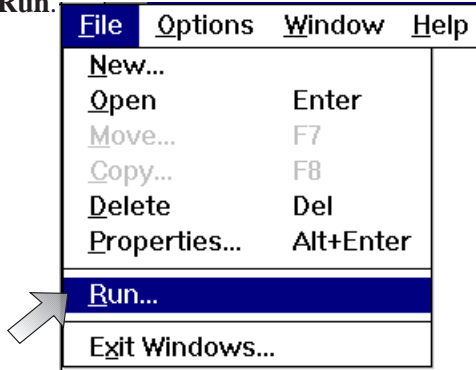

4. Type d:\setup. Click **OK**.



5. Follow the on-screen instructions to install the printer software.

Installing the OKIPAGE 6e Software for Windows NT 3.51

1. Insert the disc into the CD-ROM drive.
2. From the Main Menu select **Control Panel**.
3. Select **Printers**.
4. From the Print Manager Menu, select **Printers**.
5. **Create Printer Menu** appears. Click **Driver**, a list of printers appears. Select **Other**. Click **OK**.



6. If drive is correct, click **OK**.

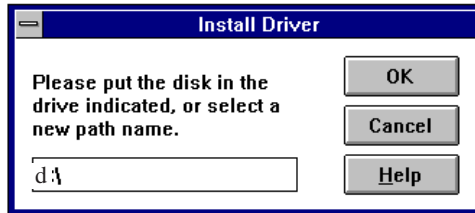

7. Click **OKIPAGE 6e driver**. Click **OK**.

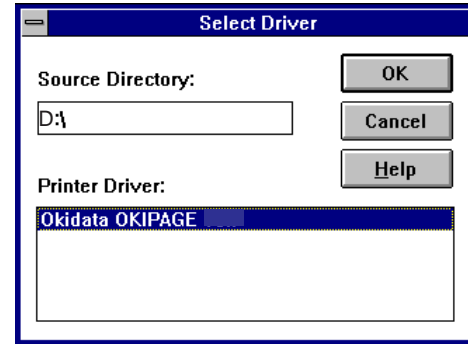

8. After driver is installed, type in a name to identify your printer.



Installing the OKIPAGE 6e Software for Windows NT 4.0

✓ *Do not use Add Printer Wizard.*

1. Turn on your computer to start Windows. **Make sure the printer is turned off.**
2. Insert the disc into the CD-ROM drive.
3. Click **Start** button from the taskbar.



4. Click **Run**.
5. Type d:\setup (or the location of your CD-ROM drive), then click **OK**.
6. Follow the on-screen instructions to install the software.
7. Turn the printer on, then restart Windows to activate the software.

Installing the DOS Operator Panel

If you are running your printer from DOS, install the DOS Operator Panel:

1. Insert the disc into the CD-ROM drive.
2. At the DOS prompt (c:>) type d: <press Enter>.
3. Type d:\install <press Enter>.
4. Follow the on-screen instructions.

Using the Status Monitor

The printer software installs a real-time status monitor and online operator panel for the user. Click the Help button for more information.

Displays printer status in text.

Shows printer status using icon colors.

Displays progress of sending print data (Win 95 only).

Displays setup of printer driver.

Closes Detail Display Panel and sets minimized view display.

Displays Printer Menu dialog to change user default settings and set display format of the Status Monitor.

Displays graphic animation of printing status.

Displays Help.

Displays printer version information.

Displays printer status and error recovery methods.

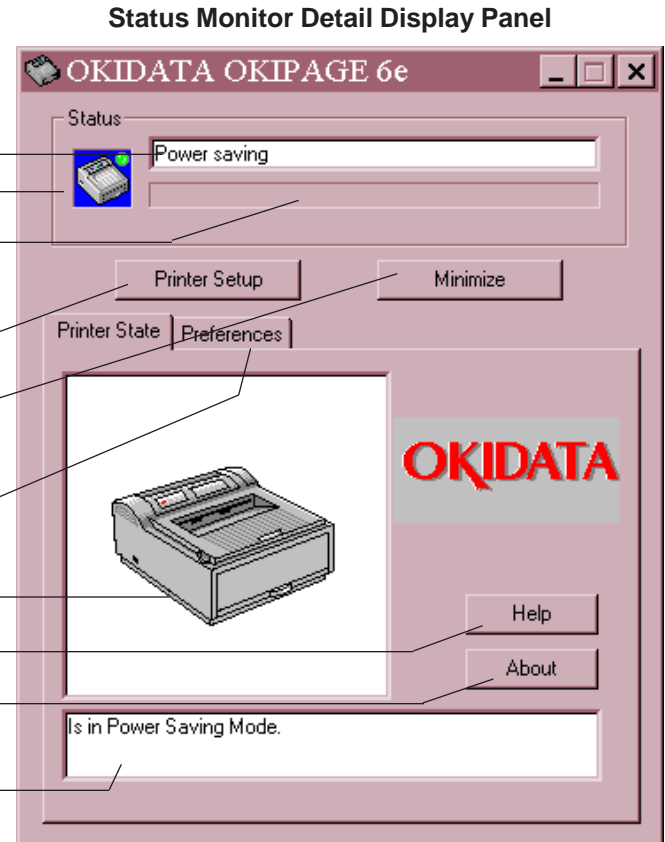

Setting Features in the Online Operator Panel

The printer menu displays printer defaults which you can modify. To change a default setting, select the appropriate tab. Point to any item on a display to see a pop-up explanation.

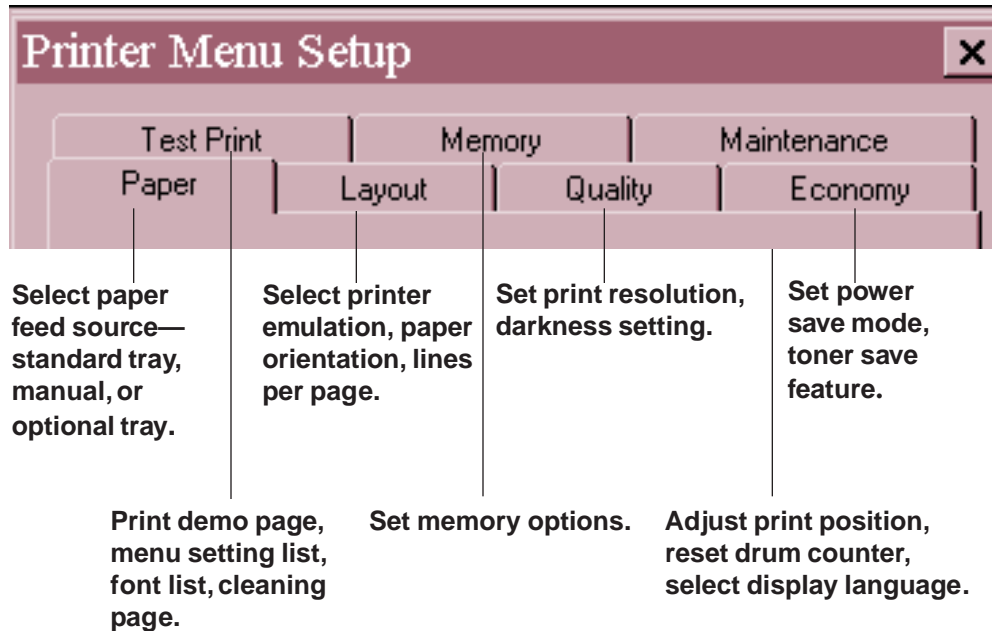

Section 3: Printer Maintenance

Replacing the Toner Cartridge

1. Open the cover and remove the used toner cartridge.



2. Unwrap the new cartridge (Part 52107201).

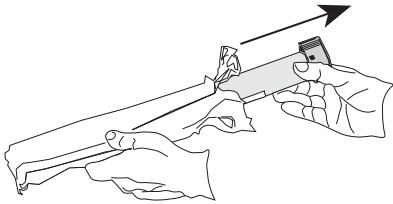

3. Shake the toner cartridge to evenly distribute toner.

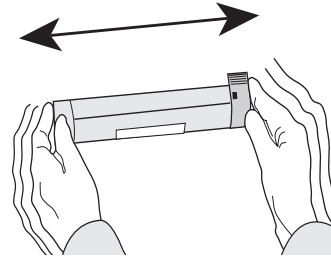

4. Peel tape off the bottom.

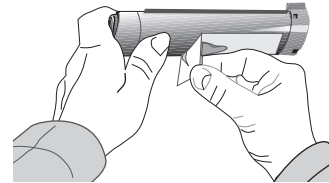

✓ *For highest print quality, we recommend using genuine Okidata consumable products in your page printer. We cannot control the manufacturing and operating characteristics of non-Okidata toner cartridges or assure the resulting print quality.*

5. Place left side of toner cartridge under tab, then lower cartridge into well matching groove and slot.

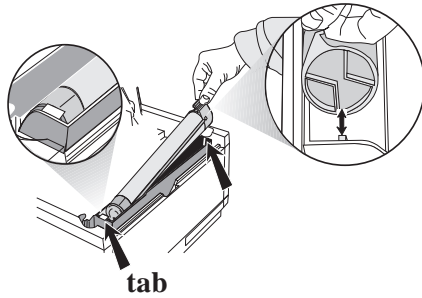

6. When the cartridge is in place, push the lock lever forward until it stops.

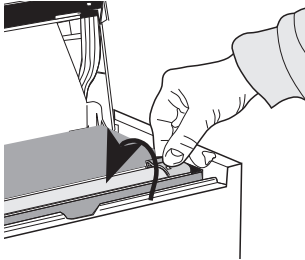

7. Close the printer cover firmly.

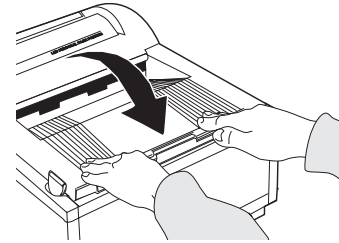

Toner Cartridge Life

How long your toner cartridge lasts depends on the print density, the percentage of the page that prints black.

A typical letter has 3% to 5% print density; graphics usually have higher density. Higher print density means toner is used up faster.

At 5% print density, a toner cartridge will print an average of 2,000 pages. Remember, this is only an average: actual results may vary.

The first toner cartridge in your new printer has to fill the drum reservoir and saturate the developing roller with toner. It normally produces about 1,000 pages.

When to Replace the Toner Cartridge

Replace the toner cartridge when you see the TONER LOW message displayed on the Status Monitor. Order **Part Number 52107201**. You can continue printing until print quality deteriorates.

Drum and Toner are consumables and as such are subject to a 90-day warranty.

Replacing the Image Drum Cartridge

1. Open the cover and remove the used image drum cartridge.

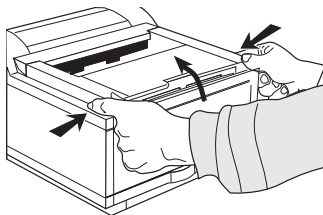

2. Unwrap the new image drum cartridge (Part 56116801). Remove the protective sheet.

✓ **Be Careful:** do not touch the *Image Drum's green surface.*

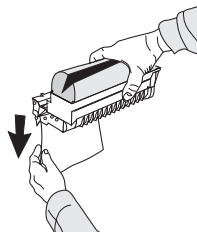

3. Replace the image drum.

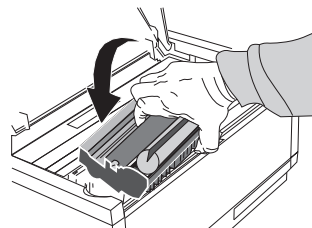

4. Install a new toner cartridge.
5. Reset the Drum Counter. (See next page).

Resetting the Drum Counter

It is important to clear the drum counter after replacing the image drum. This enables the printer to display an accurate warning message when the drum has reached end of life. If the drum is not replaced after it has reached end of life, print quality becomes poor.

1. Maximize the printer Status Monitor Display
2. Click the **Printer Menu** button
3. Click the **Maintenance** tab
4. Click the **Drum Counter Reset** button.

Image Drum Cartridge Life

The life of an image drum depends on a number of factors, including temperature and humidity, the type of paper you use, and the number of pages per job.

The image drum cartridge should last about 12,000 pages at one page per job, 16,000 pages at three pages per job, 18,000 pages at seven pages per job and 20,000 pages at fifteen pages per job. These numbers are approximate, since you do not print the same number of pages each time, and environmental conditions and paper type used may vary.

When to Replace the Image Drum Cartridge

When the drum reaches 90% of its life, the Status Monitor displays CHG DRUM. At this point, be sure you have a new drum on hand (**Part 56116801**). Replace the old one as soon as the print quality becomes faint or starts to deteriorate.

Running a Cleaning Page

The Cleaning Page process

- Removes residual impurities from printing surfaces
- Reduces problems such as repeating marks, blotching, and shading.

To generate a Cleaning Page:

1. Maximize the Printer Status Monitor Display
2. Click the **Printer Menu** button
3. Click the **Test Print** tab
4. Click the **Cleaning** button.
5. Press the push points at the front of the printer to release the manual feed tray.

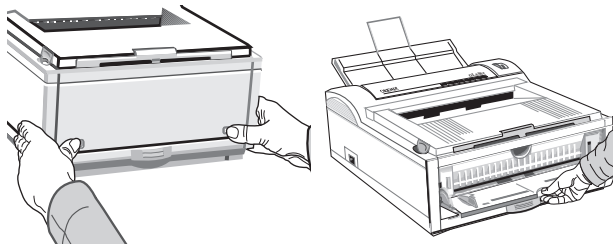

6. Pull the tray down.
7. Adjust the guides.
8. Insert a clean sheet of 8" x 11" paper.

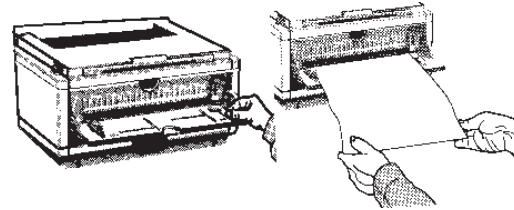

The Cleaning Page prints.

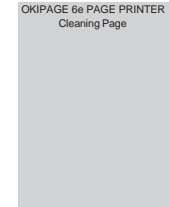

Cleaning the LED Array

Clean the LED array

- Whenever you install a new toner cartridge
- If you see faded vertical areas or light printing down a page

Wipe the LED array gently with the cleaning pad that came with your toner cartridge. You can also use a clean, soft cloth with a small amount of rubbing alcohol on it.

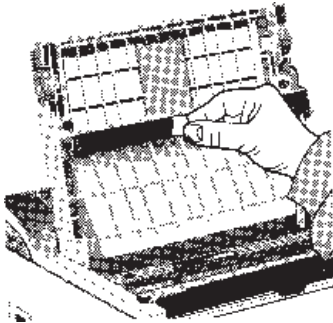

Expanding Memory

The optional 1 MB Memory Expansion Board (Part 70029701) will increase printer memory to 2 MB. The board also provides a socket for installation of an additional SIMM module for expanding memory up to 18 MB. A 1, 2, 4, 8, or 16 MB SIMM module can be installed.

The following SIMM modules have been tested and approved for use in the Okipage 6e printer.

1 MB x 32bit (70ns card type)	(Okidata Part 70019801)	Toshiba THM321020SG-70
2 MB x 32bit (70ns card type)	(Okidata Part 70019901)	Toshiba THM322020AS-70
4 MB x 32 bit (70ns card type)	(Okidata Part 70028801)	Toshiba THM324000S-70

Note: 8 and 16 MB SIMM modules are commercially available

When purchasing generic SIMM memory modules, use the following specifications:

2 MB SIMM (512 KB x 32 bit, 72 pin, 70ns, non-parity)

4 MB SIMM (1 MB x 32 bit, 72 pin, 70ns, non-parity)

8 MB SIMM (2 MB x 32 bit, 72 pin, 70ns, non-parity)

16 MB SIMM (4 MB x 32 bit, 72 pin, 70ns, non-parity)

Section 4: Problem Solving

Clearing Paper Jams

“PAPER INPUT JAM”

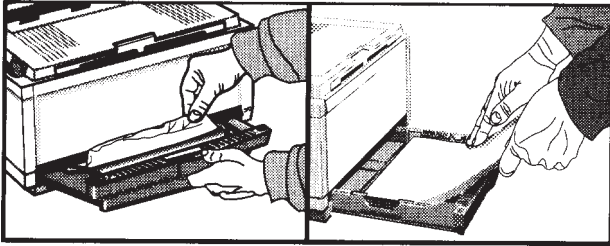

Slide the paper tray out of the printer. Remove the sheet that did not feed. Check the remaining sheets to make sure they're not wrinkled or stuck together. Replace the tray, then open and close the cover to clear the message.

“PAPER FEED JAM” or “PAPER EXIT JAM” (top jam)

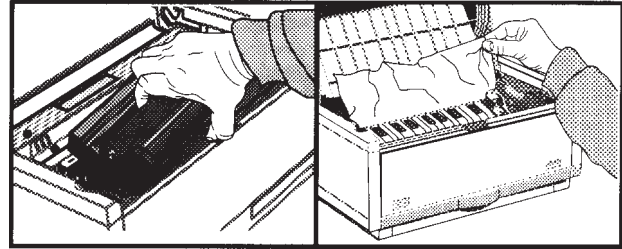

Open the cover. Lift out the image drum.

✓Be careful: the fuser unit at the back of the printer is hot!

Remove the jammed paper. Replace the image drum. Close the cover.

“PAPER EXIT JAM” (rear jam)

Lift the top cover. Pull the jammed paper out from the *back* of the printer. *Pulling from the front may damage the printer.* Remove the image drum and look to make sure the paper is cleared and no pieces are left. Replace the image drum and close the cover.

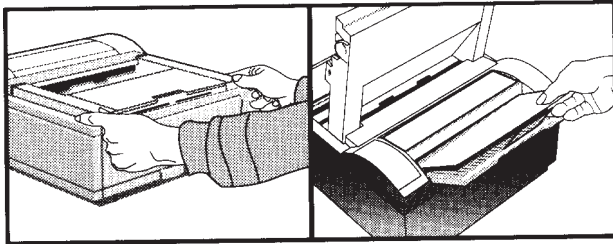

Print Quality Problems

Before consulting a service representative regarding a print quality problem, check the table below to see if there is a solution, or something you might have overlooked.

Symptom	Problem	Solution
Blank sheets printed.	Image drum cartridge not properly installed. Empty or missing toner cartridge.	Reinstall image drum cartridge. Install new toner cartridge.
Entire page prints faintly.	Pages get fainter when toner is used up. LED array is dirty.	Install new toner cartridge. Clean LED array.
Page has gray background.	Static electricity, generally from dry environments, causes toner to stick to background.	Change papers to a smoother laser bond or use a humidifier.
Page prints all black.	Hardware problem.	Contact your service representative.
Page has repetitive marks.	Damaged image drum cartridge causes repetitive marks every 1.6 inches due to surface nicks and scratches.	Generate a Cleaning Page, repetitive marks may be temporary. Install a new image drum cartridge.
An oblong area of faint print	“Dropout” caused by using paper exposed to high humidity. appears on each page	Change paper stocks, check paper storage environment or use a dehumidifier; check toner.
Vertical white streaking or faint print appears on the page	Toner is low and does not distribute properly, or the drum is worn out.	Replace toner cartridge. Check drum and replace if necessary. Contact service.

Vertical black lines.	LED array is dirty. Is toner low? Hardware problem.	Clean LED array. Replace toner cartridge. Contact service.
Fuzzy print	LED array is dirty.	Clean LED array.
Distorted print	Paper path, lamp assembly, or fusing unit problem.	Generate Cleaning Page. Contact service.
Faded print after installation.	Toner cartridge is not correctly installed.	Install toner cartridge correctly.
Smearred or blotched print	Dirty rollers; toner dropped inside printer or image drum problem.	Generate Cleaning Page. Contact service.
Printed page is light or blurred.	Is toner low? Is paper meant for laser printers? LED array is dirty.	Replace toner cartridge. Use recommended paper. Clean LED array.
Bold characters and dark lines are smearred.	Toner is low.	Install new toner cartridge.
Print is darker than usual.	Darkness setting is too high.	Change darkness setting.
Pages curl excessively	Printing on wrong side of paper. High humidity. Moisture in paper. High humidity.	Turn paper over in tray. (Note arrow on paper package). Install paper print side down in tray. Improper storage. Avoid storing paper in areas of excessive temperature changes and humidity. Store paper in protective wrapping. Recommended operating humidity: 20-80%

Software Problems

Your software (operating environment, applications and printer drivers) controls the printing process. Make sure you have selected the right driver for use with your printer. See your software documentation for more information.

Symptoms	Problem	Solution
Printing is “garbled.”	Incorrect driver is installed, or selected in your software.	Select the appropriate printer driver in your software application and in Windows control panel.
Printer’s output is below rated speed.	Much of the printing delays will be caused by your application. Sometimes, purely text documents will print slowly depending on the selected fonts and how they are transferred to the printer.	For maximum speed, use text in your document and use a printer resident font. (To see printer resident fonts, print a font list from the printer's online menu).
Size of top margin increases with each page printed.	“Creeping text.” Number of lines per page in software is not equal to number of lines per page of printer.	Many software packages assume 66 line per page, but your printer's default is 60. Adjust software accordingly, or set LINES per PAGE in the printer's online operator panel to equal lines per page in your software.

Hardware Problems

Symptoms

Graphic image prints partly on one page, partly on the next.

When you try to print nothing happens, but printer indicates it is ready to receive data.

“Garbage” prints.

Printer freezes or displays error message when computer is rebooted.

Odors.

Printer is on but must “warm up” before a job is printed.

Online Status Monitor indicates that there is a communications problem.

Problem

Insufficient printer memory for this image

Configuration error.

Check cable configuration, continuity, and length.

Booting the computer while the printer is on communications error.

Gases are given off by forms or adhesives passing through the hot fusing unit.

Power Save mode is set on to conserve energy. The fuser must heat up before you can begin printing the next job.

Incorrect interface cable being used.

Printer is not connected directly to the bidirectional parallel port.

Solution

Install more memory in your printer, change the resolution, reduce the image size.

Check cable connection. If more than one printer is available, make sure your printer has been selected.

Incorrect cable configuration. (Also, see “Software Problems.”)

Turn printer off before rebooting computer.

Make sure the forms you are using can withstand heating; provide adequate ventilation.

To eliminate warmup delay, change Power Save setting in printer's online operator panel.

Verify that the interface cable is bidirectional, conforming to IEEE-1284 standards.

Printer must be connected directly to port; no switching device, external print buffer, scanning device, etc. can be attached to port.

Section 5: Service and Support

This information is valid for the United States and Canada.

Your Dealer

Consult the store where you purchased your printer, or call 1-800-OKIDATA for the location of the nearest authorized OKIDATA service dealer. Have your Zip code ready. Proof of purchase is required for warranty work, be sure to retain your purchase documents.

The Okidata Customer Information Center

For customer service call 1-800-OKIDATA. The Okidata Information System Automated Attendant is available 24 hours a day, 7 days a week. The system can provide immediate assistance with:

- Basic Operating Procedures
- Sales and Service Referrals
- Parts and Consumable Referrals
- Product Information

Okidata Customer Service Representatives

Agents are available 24 hours a day, 7 days a week. Please be sure that you are calling from a telephone close to your printer, so you can describe your problem accurately. Our Customer Service Representatives are trained on all current Okidata products. They can answer your questions regarding:

- Installation of your Okidata printer
- Determination of printer issues that require service
- Consumer relations
- Interface Information
- Availability and installation of printer drivers (*CSRs are not trained to provide assistance with the use of commercial software packages. Please consult your software user's manual for times and availability of their support.*)

Faxable Facts

You can have product and support information faxed automatically to you through Okidata's Faxable Facts, an on-line document retrieval system. A touch-tone telephone and facsimile machine with a designated telephone number are required.

Call toll-free at 1-800-654-6651, press option 2 to hear a description of how Faxable Facts works. If you are calling for the first time, order a catalog of available documents. This faxback system is accessible 24 hours a day, 7 days a week. The following information can be faxed to you in minutes:

- Product data brochures
- Product part numbers and pricing (USA and Canadian)
- User Tips
- Accessories, Options, and Consumables part numbers and pricing (USA and Canada)

Okidata Regional Service Center

If you need to ship your printer to a service center, repack it in the original packing materials. If the original packaging is not available, contact your dealer or 1-800-OKIDATA for shipping instructions.

- Allow 30 days for round trip shipping and repair via a depot.
- Carry-in repairs must first be called in to schedule service.
- Before shipping your printer, call for a return authorization number (RA).

Okidata Service Centers

East

OKIDATA Service Depot
57 Carnegie Plaza
Cherry Hill, NJ 08003
Tel: 1-800-809-4948
Fax: 1-609-222-5247

Okidata Service Centers (cont'd)

Central

OKIDATA Service Depot
851 Feehanville Drive
Mt. Prospect, IL 60056
Tel: 1-800-809-4948

Canada

OKIDATA Service Depot
2735 Matheson Blvd., East
Unit 1
Mississauga, Ontario L4W4M8
Tel: 905-238-4265
Fax: 905-238-4427

Purchasing Supplies

Before you order, know your printer model number (see the front of the printer) and have the correct part number and description of the item.

Ways to Purchase

- Consult the dealer where you purchased your printer.
- Consult an Okidata Authorized Sales or Service Dealer.
- Call 1-800-OKIDATA for the nearest Authorized Sales and Service location. Have your ZIP code ready for our Customer Support Representatives.
- Check office supply catalogs or your local stationery store. Most carry Okidata brand supplies.

LIMITED WARRANTY

OKIDATA, division of OkiAmerica, Inc. (OKIDATA) warrants this printer to be free from defect in material and workmanship and will remedy any such defect according to the terms of this *Limited Warranty*.

OKIDATA will repair (or at its option, replace) at no charge, any defective component(s) of the Printer for one (1) year from the date of purchase except for the printhead (LED imaging array), which is warranted for a period of five (5) years from date of purchase. This *Limited Warranty* extends to the original purchaser only. This *Limited Warranty* does not extend to consumable items.

To make request or claim for service under this *Limited Warranty* the original purchaser has the option to implement the overnight exchange procedure (U.S and Canada only; see Overnight Exchange) or return the OKIDATA product, shipping prepaid, in the original shipping container or equivalent, to OKIDATA or an authorized OKIDATA service center and assume the risk of loss or damage in transit. A written receipt for the product, showing the date of purchase, dealer's name, and both the model and serial numbers of the OKIDATA printer must accompany any request or claim for work to be performed under this *Limited Warranty*.

This *Limited Warranty* shall not apply if the product has been damaged due to abuse, misuse, misapplication, accident, or as a result of service or modification by any other than an authorized OKIDATA service center.

THERE ARE NO EXPRESS WARRANTIES OTHER THAN THOSE ON THE FACE HEREOF AND DESCRIBED ABOVE. NO WARRANTIES WHETHER EXPRESS OR IMPLIED, INCLUDING, BUT NOT LIMITED TO, ANY PARTICULAR PURPOSE, SHALL EXTEND BEYOND THE RESPECTIVE WARRANTY PERIOD DESCRIBED ABOVE. Some states do not allow limitations on how long an implied warranty lasts, so the above limitation may not apply to you.

OKIDATA SHALL NOT BE RESPONSIBLE OR LIABLE FOR ANY SPECIAL, INCIDENTAL OR CONSEQUENTIAL DAMAGES OR LOSS ARISING FROM THE USE OF THIS PRODUCT. Some states do not allow the exclusion or limitation of incidental or consequential damages, so the above exclusion may not apply to you.

Additional information on obtaining service under this *Limited Warranty* is available by contacting the OKIDATA dealer from whom the product was purchased, by contacting OKIDATA directly at 1-800-OKIDATA (U.S. and Canada, English only) or 1-609-222-5276 (Spanish only), or by contacting one of the service depots listed.

This *Limited Warranty* applies to this OKIDATA printer. However, the procedure for obtaining service may vary outside the continental United States. Contact your OKIDATA dealer for such warranty service information.

This warranty gives you specific legal rights, and you may also have other rights which vary from state to state.

OVERNIGHT EXCHANGE

Available in the United States and Canada

If you choose to use our Overnight Exchange service, call 1-800-OKIDATA: our trained personnel will try to solve your problem over the phone. If they determine that your printer hardware is defective, an exchange machine will be shipped to you via air express. Have your credit card available as our representative will be asking for this information. You will receive the exchange machine the next business day—or no later than the second business day.

Return the original machine to OKIDATA by using the same packaging materials you received with the exchange printer, and making it available to pickup by OKIDATA's representative within 2 business days from your receipt of the exchange machine: failure to do so may result in your being charged the full price of the exchange unit . Before you ship the printer, remove the image drum and toner cartridge to prevent damage to the printer during shipment: failure to do so may result in a fee for cleaning/repairs which will be charged to your account.

When Overnight Exchange is used, the returned machine becomes the property of OKIDATA. Exchange machines may be new or repaired, at the option of OKIDATA: the exchange machine becomes the property of the customer when the returned machine had been picked up by OKIDATA's designated carrier. The exchange printer will be warranted for thirty (30) days or the remaining warranty period of the returned printer, whichever is longer.

Overnight Exchange of the printer for a printhead failure is limited to one year from date of purchase. For the remaining printhead warranty period, replacement will be at an authorized service center or authorized third party service organization. Call 1-800-OKIDATA for authorized service locations.

OKIDATA SERVICE CENTERS

UNITED STATES

OKIDATA

Tel: 1-800-809-4948

Fax: 1-609-222-5247

CANADA

OKIDATA

Tel: 905-238-4265

Fax: 905-238-4427

MEXICO

Oki Data de Mexico, S.A. de C.V.

Tel: 525-661-6860

Fax: 525-661-5861

Compu Support

Tel: 915-559-3022

Fax: 915-559-3267

C-Sercomp

Tel: 915-581-2166

Fax: 915-697-6366

ROM Mayoreo Mexico

Phone/Fax: 525-682-3407

ARGENTINA

Free Distribuidores Mayorisstas

Fax: 54-41-259250

Tel: Buenos Aires: (01)300-0052

Tel: Cordoba: (051)61-4060

Tel: Rosario: (041)49-4440

CHILE

Teknos Comunicaciones

Tel: 56 (2) 555 5530

Fax: 56 (2)550 2390

VENEZUELA

MAI de Venezuela S.A.

Tel: 782.78.11

Fax: (02)781.9390

COLOMBIA

Texins S.A.

Tel: 571-218-5300

BRAZIL

Oki Data do Brasil, Ltda.

Av. Leonardo da Vinc

1178/1182 Jabaquara

Sao Paulo, Brasil

Tel: (5511) 5589-1518

Fax: (5511) 5584-0267

NYTEK

Rua Pe. Francisco Libermann

301 Cidade Sao Francisco

Sao Paulo CEP 05353-160

Tel: (011) 819-0211

Fax: (011) 819-3496

NYTEK

Rua Paranapanema

122 Jd. Rio das Pedras

Cotia, Sao Paulo CEP 06700-000

Tel: (011) 7924-0796, 7, 8

Fax: (011) 493-3234

INDEX

A

Accessories, 1

C

CHG DRUM message, 23

Cleaning page, 24

Components, 3

Consumables, 1

Counter, Image Drum, 23

D

DPI (dots per inch), 1

DOS Operator Panel, 16

Default settings, 18

E

Emergency first aid procedures, 39

Energy Star compliance, 1

Envelopes

 choosing, 11

 how to print, 11

F

Faxable Facts, 34

H-I

Hardware problems, 32

OKIPAGE 6e

Image drum cartridge

 CHG DRUM message, 23

 counter, resetting, 23

 environmental factors, 23

 how to replace, 22

 life, 23

 part number, 1,23

 when to replace, 23

Interface cable. *See* Parallel cable

L

Labels

 choosing, 10

LED array

 how to clean, 25

 location of, 25

 when to clean, 25

M-O

Manual Feed

 how to use, 10

 when to use, 10

Material Safety Data Sheet (MSDS), 39

Memory, expanding, 1, 26

Menu, printer, 18

Okidata Service Centers, 34, 38

Online Manual, 2

Online Operator Panel, 18

Optional Accessories, 1

Ovrnight exchange, 37

P

Paper

- choosing, 7
- installing, 8
- letterhead, 10
- preprinted forms, 7
- recycled paper, using, 7
- size, 7

Paper Exit

- rear exit, 9
- top exit, 9

Paper jams, 27

Paper tray, 8

- adjusting guides, 8
- removing from printer, 8

Parallel cable

- bi-directional, 12
- installing, 12
- specifications, 12

Print quality problems, 29

PPM (Pages per minute), 1

Printer software

- installing, 13
- Windows 3.1, 14
- Windows 95, 13
- Windows NT 3.51, 15
- Windows NT 4.0, 16

Problem solving, 27

- hardware, 32
- print quality, 29

software, 31

Protective sheet

removing, 4

Purchasing supplies, 35

R

Rear paper exit

- how to set up, 9
- tray capacity, 9
- when to use, 9

Regional Service Depots, 34

Resolution, 1

S

Service, 33-34

- Authorized Okidata Service, 34, 38
- Customer Information Center, 33
- depots, Okidata, 34
- Faxable Facts, 34

SIMMS, installing, 26

Software

installing printer, 13

Status Monitor, using, 17

Supplies, purchasing, 35

T

Toner

- in eyes, 39
- ingested, 39

- inhaled, 39
- installing, 5
- Toner cartridge
 - first cartridge life, 21
 - how to replace, 19
 - life, 21
 - when to replace, 21
 - part number, 1,21
- TONER LOW message, 21
- Top paper exit
 - bin capacity, 9
 - how to set up, 9
- Transparencies
 - choosing, 10
- Troubleshooting
 - hardware problems,32
 - print quality problems, 29
 - Software problems, 31
 - Clearing paper jams, 27

U-W

- Unpacking contents, 3
- Warranty, 36
- Web Site-Okidata, 2
- Windows 3.1 printer driver, 14
- Windows 95 printer driver, 13
- Windows NT 3.51 driver, 15
- Windows NT 4.0 driver, 16

MATERIAL SAFETY DATA SHEET

OL “e” Series Toner

MSDS # 58093101

For more information, contact Okidata at:

532 Fellowship Road

Mount Laurel, NJ 08054

Emergency Information: 1-800-OKIDATA

EMERGENCY FIRST AID PROCEDURES

Emergency	Procedure
Toner swallowed (ingested)	Dilute by giving two glasses of water and induce vomiting by administering Syrup of Ipecac (follow manufacturer’s instructions). Seek medical attention. <i>NEVER give anything by mouth or attempt to induce vomiting in a person who is unconscious.</i>
Toner inhaled	Remove person to fresh air. Seek medical attention.
Toner gets in the eyes	Flush eyes with large quantities of cool water for 15 minutes, keeping the eyelids open with fingers. Seek medical attention.
Note	Small amounts of toner on skin or clothing can easily be removed with soap and <i>cold</i> water. Hot water makes toner harder to remove.

Hazardous Ingredients

Styrene-Butyl Acrylate Copolymer (91% by weight)

CAS# 25767-47-9

OSHA TWA 15 mg/m3 for total dust

ACGIH TLV 10 mg/m3 for total dust

Carbon Black (5-7% by weight)

CAS# 1333-86-4

OSHA TWA 3.5 mg/m3

ACGIH TLV 3.5 mg/m3

Polypropylene (less than 3% by weight)

CAS# 9003-07-0

OSHA TWA 15 mg/m3 for total dust

ACGIH TLV 10 mg/m3 for total dust

Amorphous Fumed Silica (less than 1% by weight)

CAS# 67762-90-7

OSHA PEL 15.0 mg/m3 for total dust

ACGIH TLV 10.0 mg/m3 for total dust

Note This product is not regulated under Section 313 of SARA, Title III.

Physical Data

Melting Point: 110°C (230°F)

Boiling Point: Not applicable

Vapor Pressure: Not applicable

Vapor Density (Air=1): Not applicable

Evaporation Rate (ButylAcetate=1): Not applicable

Specific Gravity (H2O=1): 1.15

Solubility in water: Negligible

Appearance and odor: Black granules, no odor

Fire and Explosion Hazard Data

Flash Point (Method Used): Not applicable

Flammable Limits

Lower Explosive Limit: Not applicable

Upper Explosive Limit: Not applicable

Extinguishing Media: Water, CO₂, Dry Chemical, or Foam

Special Fire Fighting Procedures: Do not use methods that may create a dust cloud, such as high pressure water and/or steam

Unusual Fire and Explosion Hazards:

—Organic components decompose at 200-455°C (392-851°F).

—Material may explosively combust when finely suspended in air.

—Thermal decomposition of organic components may result in release of oxides of carbon and nitrogen.

Health Hazard Data

Routes of Entry: Inhalation, Ingestion, Eyes, Skin.

Health Hazards:

1. Styrene-Butyl Acrylate Copolymer

Subcutaneous implantation of polymeric styrene powder in rats has induced tumors at the site of implantation.

2. Carbon black

(Group 3 “Not Classifiable”; IARC)

Overexposure to carbon black is associated with causing irritation, conjunctivitis, and corneal hypoplasia of the eyes; minor irritation and eczema of the skin; and throat irritation and bronchitis.

Long-term inhalation exposure may be associated with causing lung cancer.

3. Polypropylene

(Group 3 “Not Classifiable”; IARC)

Subcutaneous implantation of polypropylene powder in rats has induced tumors at the site of implantation.

4. Amorphous Fumed Silica

(Group 3 “Not Classifiable”; IARC)

Overexposure to amorphous silica has been associated with causing irritation of the lungs and pneumoconiosis. Long-term inhalation exposure may be associated with producing tumors in laboratory animals.

Reactivity Data

Stability: Stable

Polymerization: Will not occur.

Hazardous Decomposition Products: Thermal decomposition may result in release of oxides of carbon and nitrogen.

Temperature: Do not expose to temperatures above 200°C (392°F).

Incompatibility: Avoid exposure to strong oxidizers.

Spill Cleanup and Disposal

Spill Cleanup

Small Spills

1. *Remove sources of ignition.*

2. Clean up spill with wet cloth.

Large Spills

1. *Remove sources of ignition.*
2. Wear protective gear: respirator, rubber gloves, goggles (see below)
3. Clean up spill with scoop, *being careful not to generate a lot of dust.*

Waste Disposal: Follow appropriate federal, state and local regulations.

Safe Handling and Use

Respiratory Protection: Not normally required. For large spills, use NIOSH-approved full face-piece respirator with HEPA cartridge during cleanup.

Protective Gloves and/or Eye Protection: Not normally required. For large spills, use rubber gloves and chemical worker's goggles during cleanup.

Ventilation: Outside of normal ventilation, not normally required.

Other Protective Equipment and/or Hygienic

Practices: None

Special Precautions

Precautions for Handling or Storage: Protect from high heat. Avoid making dust.

Other Precautions: None

The information contained in this MSDS is based on data considered accurate; however, no warranty is expressed or implied regarding the accuracy of these data or the results to be obtained from the use thereof. Vendor assumes no responsibility for injury to vendee or third person party proximately caused by the product if reasonable safety procedures are not adhered to as stipulated in the MSDS. Furthermore, vendor assumes no responsibility for injury to vendee or third person party proximately caused by abnormal use of the product even if reasonable safety procedures are followed. Additionally, vendee assumes the risk of his use of the product.

June 1997